

Write your name here

Surname

Other names

Pearson Edexcel
International GCSE

Centre Number

--	--	--	--	--

Candidate Number

--	--	--	--

Mathematics B

Paper 2



Thursday 9 June 2016 – Morning
Time: 2 hours 30 minutes

Paper Reference
4MB0/02

You must have: Ruler graduated in centimetres and millimetres, protractor, compasses, pen, HB pencil, eraser, calculator. Tracing paper may be used.

Total Marks

Instructions

- Use **black** ink or ball-point pen.
- **Fill in the boxes** at the top of this page with your name, centre number and candidate number.
- Answer **all** questions.
- Answer the questions in the spaces provided
– *there may be more space than you need.*
- **Calculators may be used.**

Information

- The total mark for this paper is 100.
- The marks for **each** question are shown in brackets
– *use this as a guide as to how much time to spend on each question.*

Advice

- Read each question carefully before you start to answer it.
- Check your answers if you have time at the end.
- Without sufficient working, correct answers may be awarded no marks.

Turn over ►

P45918A

©2016 Pearson Education Ltd.

1/1/1/1/1/



PEARSON

Question 1 continued

DO NOT WRITE IN THIS AREA

DO NOT WRITE IN THIS AREA

DO NOT WRITE IN THIS AREA

Handwriting practice area consisting of 28 horizontal dotted lines.

(Total for Question 1 is 4 marks)



$$2 \quad \mathbf{A} = \begin{pmatrix} -3 & -2 \\ 5 & 3 \end{pmatrix} \quad \mathbf{B} = \begin{pmatrix} 4 & 1 \\ -2 & -1 \end{pmatrix} \quad \mathbf{C} = \begin{pmatrix} 4 & 7 \\ -6 & -10 \end{pmatrix}$$

(a) Find \mathbf{AB} .

(2)

(b) Given that $\mathbf{AB} - \mathbf{C} = \lambda\mathbf{A}$ where λ is an integer, find the value of λ .

(3)

DO NOT WRITE IN THIS AREA

DO NOT WRITE IN THIS AREA

DO NOT WRITE IN THIS AREA



Question 2 continued

DO NOT WRITE IN THIS AREA

DO NOT WRITE IN THIS AREA

DO NOT WRITE IN THIS AREA

Area with horizontal dotted lines for writing.

(Total for Question 2 is 5 marks)



3

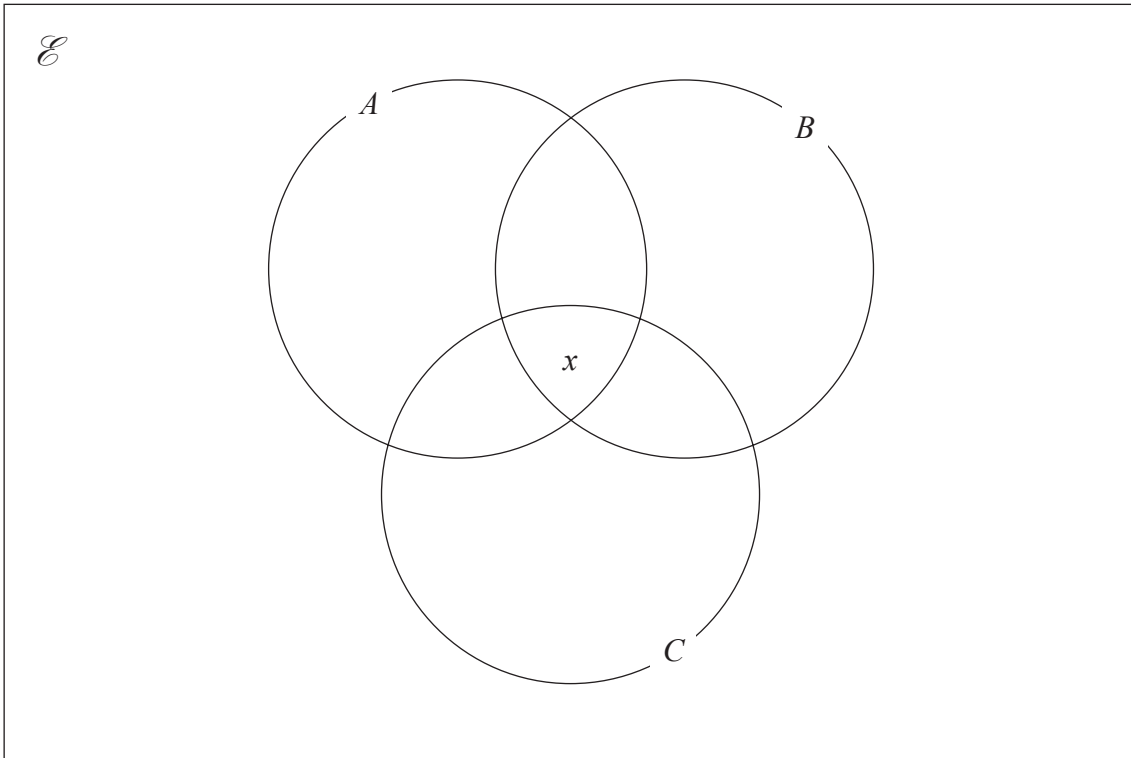

In the Venn diagram, $n(A \cap B \cap C) = x$

It is given that sets \mathcal{E} , A , B and C are such that

$$n(\mathcal{E}) = 60$$

$$n([A \cup B \cup C]') = 4$$

$$n(A \cap B) = 8$$

$$n(B \cap C) = 7$$

$$n(A \cap C) = 13$$

$$n(A) = 37 - x$$

$$n(B) = 28 - x$$

$$n(C) = 29 - x$$

(a) Using this information, complete the Venn diagram to show the number of elements in each appropriate subset.

(3)

(b) (i) Using your Venn diagram, write down an equation in x .

(ii) Hence find the value of x .

(2)

.....

.....

.....

.....



Question 3 continued

DO NOT WRITE IN THIS AREA

DO NOT WRITE IN THIS AREA

DO NOT WRITE IN THIS AREA

Area with horizontal dotted lines for writing.

(Total for Question 3 is 5 marks)



Question 4 continued

DO NOT WRITE IN THIS AREA

DO NOT WRITE IN THIS AREA

DO NOT WRITE IN THIS AREA

Area with horizontal dotted lines for writing.

(Total for Question 4 is 7 marks)



Question 5 continued

- (c) On the grid below complete the histogram to represent the information in the table.
One bar has been drawn for you.

(4)

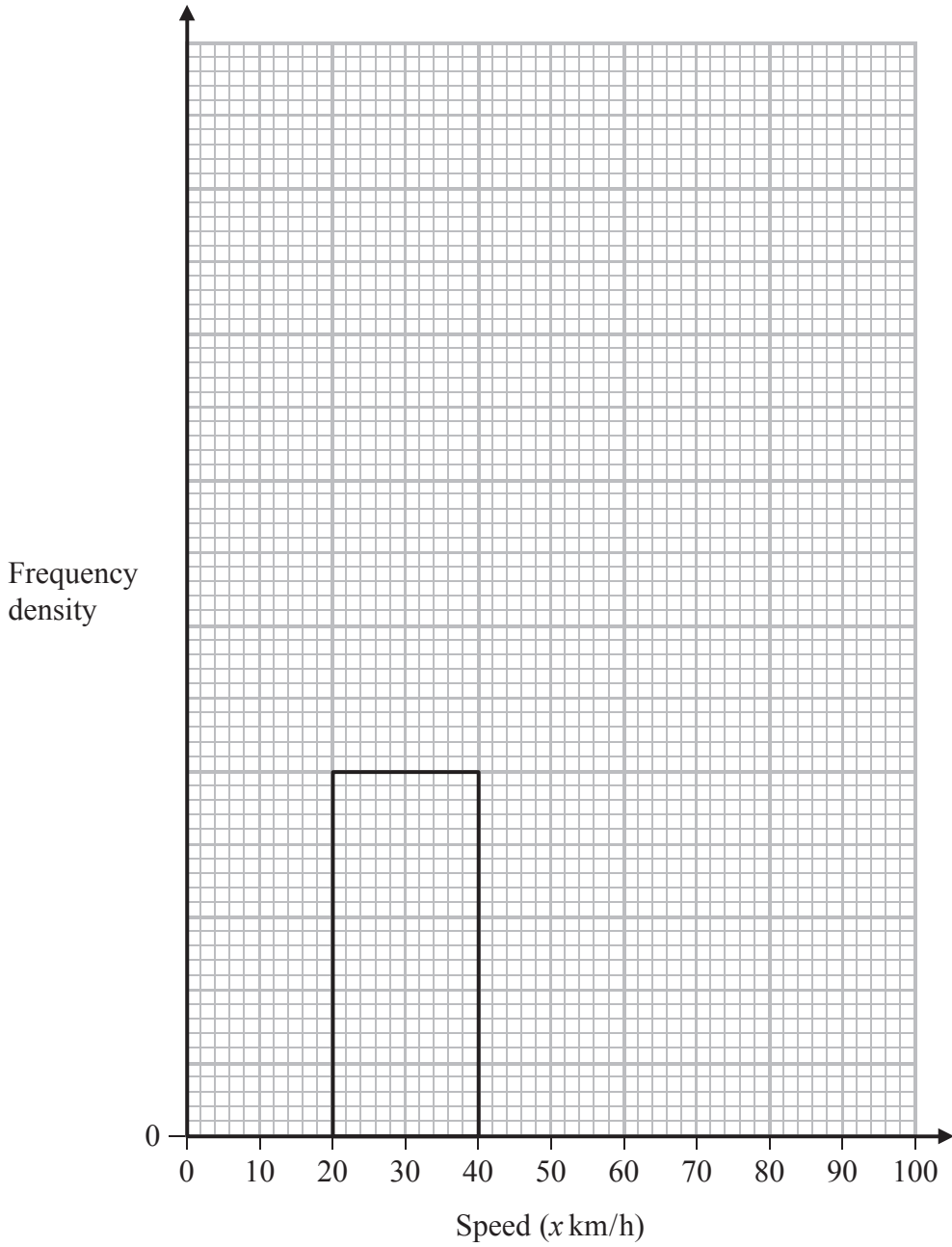

DO NOT WRITE IN THIS AREA

DO NOT WRITE IN THIS AREA

DO NOT WRITE IN THIS AREA



Question 5 continued

Area with horizontal dotted lines for writing.

DO NOT WRITE IN THIS AREA

DO NOT WRITE IN THIS AREA

DO NOT WRITE IN THIS AREA

(Total for Question 5 is 10 marks)



DO NOT WRITE IN THIS AREA

DO NOT WRITE IN THIS AREA

DO NOT WRITE IN THIS AREA

6 Simplify fully $\frac{x^2 + 3x - 28}{(x + 3)^2 - 16}$

Handwriting practice area with horizontal dotted lines.

(Total for Question 6 is 5 marks)



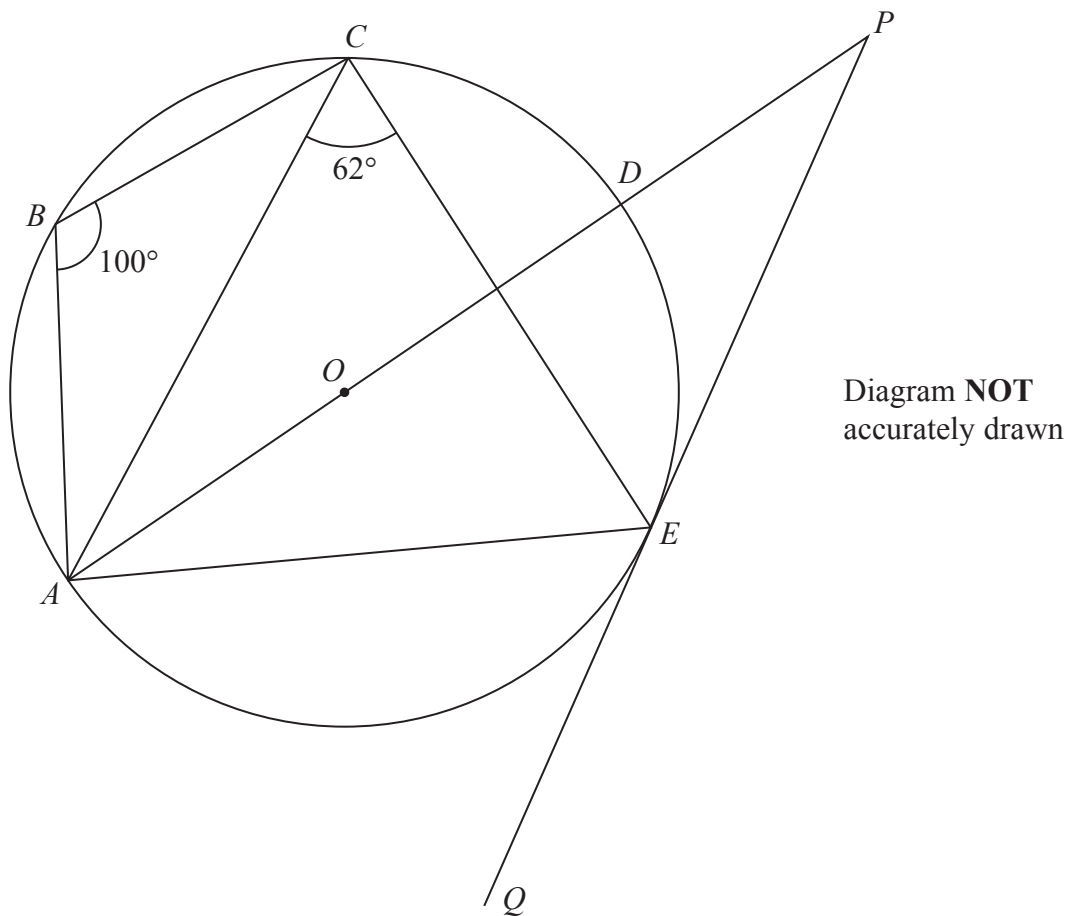

Figure 1

In Figure 1, $ABCDE$ is a circle with centre O and with diameter AD .
 ADP and QEP are straight lines so that QEP is the tangent to the circle at the point E .
 $\angle ABC = 100^\circ$ and $\angle ACE = 62^\circ$

- (a) Giving reasons, find the size, in degrees, of
 - (i) $\angle AEC$,
 - (ii) $\angle AEQ$.(4)

- (b) Giving reasons, show that $\angle OAE = 28^\circ$ (4)

- (c) Hence find the size, in degrees, of $\angle EPA$. (2)



Question 7 continued

DO NOT WRITE IN THIS AREA

DO NOT WRITE IN THIS AREA

DO NOT WRITE IN THIS AREA

Area with horizontal dotted lines for writing.



P 4 5 9 1 8 A 0 1 5 3 6

Question 7 continued

Handwriting practice area consisting of 25 horizontal dotted lines.

DO NOT WRITE IN THIS AREA

DO NOT WRITE IN THIS AREA

DO NOT WRITE IN THIS AREA



Question 7 continued

DO NOT WRITE IN THIS AREA

DO NOT WRITE IN THIS AREA

DO NOT WRITE IN THIS AREA

Area with horizontal dotted lines for writing.

(Total for Question 7 is 10 marks)



- 8 (a) Expand and simplify $(5x + 192)(x - 80)$ (2)

The manager of a golf shop bought x identical golf balls at a total cost of \$480 to sell during a tournament.

- (b) Write down an expression in terms of x for the price, in \$, that the manager paid for one golf ball. (1)

The selling price of a golf ball was such that the profit made when the golf ball was sold is \$2.50

- (c) Find, as a single fraction, an expression in terms of x for the selling price, in \$, of one golf ball. (2)

At the end of the tournament, 16 of the golf balls had **not** been sold and the total selling price of the golf balls sold was \$544

- (d) Using all the information given, write down an equation in x . (1)

- (e) Show that your equation in part (d) simplifies to $5x^2 - 208x - 15\,360 = 0$ (3)

- (f) Using part (a) or otherwise, find the number of golf balls bought by the manager of the golf shop for the tournament. (3)

.....

.....

.....

.....

.....

.....

.....

.....

.....

.....

.....

.....

.....

.....

.....

.....

.....

.....

.....

.....

.....

.....

.....



Question 8 continued

DO NOT WRITE IN THIS AREA

DO NOT WRITE IN THIS AREA

DO NOT WRITE IN THIS AREA

Handwriting practice area with 25 horizontal dotted lines.



P 4 5 9 1 8 A 0 1 9 3 6

Question 8 continued

Handwriting practice area consisting of 25 horizontal dotted lines.

DO NOT WRITE IN THIS AREA

DO NOT WRITE IN THIS AREA

DO NOT WRITE IN THIS AREA



Question 8 continued

DO NOT WRITE IN THIS AREA

DO NOT WRITE IN THIS AREA

DO NOT WRITE IN THIS AREA

Area with horizontal dotted lines for writing.

(Total for Question 8 is 12 marks)



P 4 5 9 1 8 A 0 2 1 3 6

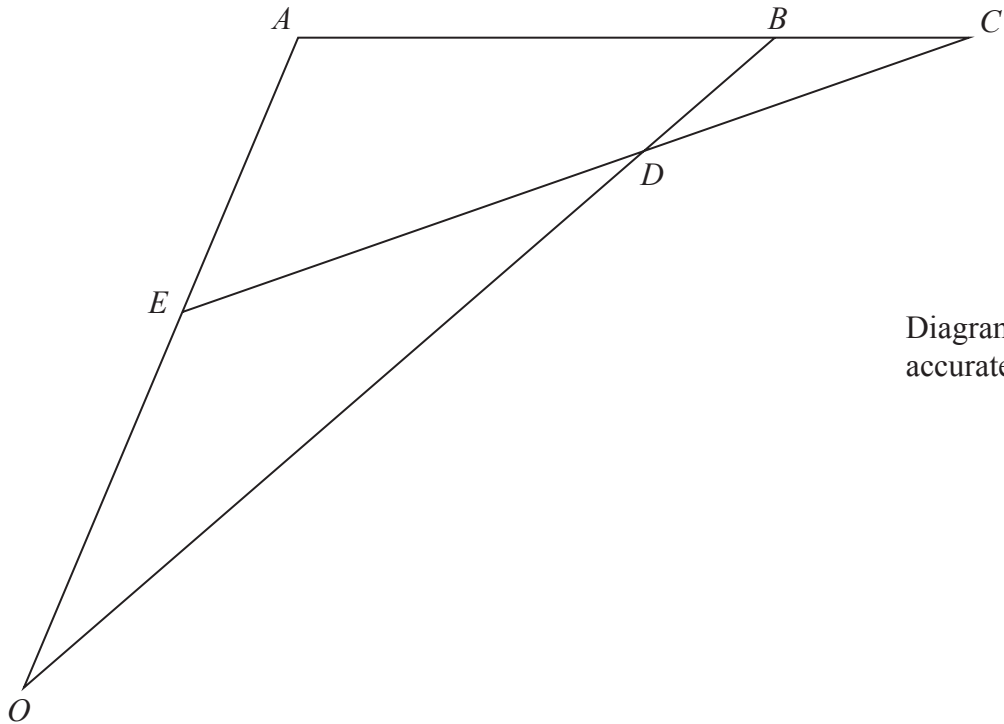

Diagram **NOT**
accurately drawn

Figure 2

In Figure 2, OAB is a triangle such that $\vec{OA} = 2\mathbf{a}$ and $\vec{AB} = \mathbf{b}$.
The point E is the midpoint of OA and ABC is a straight line such that $AB:AC = 4:5$.
The lines OB and CE intersect at the point D .

(a) Express in terms of \mathbf{a} and \mathbf{b} or \mathbf{a} or \mathbf{b}

(i) \vec{OB} (ii) \vec{AC} (iii) \vec{EC}

(3)

Given that $\vec{OD} = \mu\vec{OB}$, where μ is a scalar,

(b) write down an expression for \vec{OD} in terms of μ , \mathbf{a} and \mathbf{b} .

(1)

Given also that $\vec{ED} = \lambda\vec{EC}$, where λ is a scalar,

(c) write down an expression for \vec{OD} in terms of λ , \mathbf{a} and \mathbf{b} .

(1)

(d) Find the value of λ and the value of μ .

(5)

The area of triangle OAD is 20 square units.

(e) Find the area of triangle ADB .

(2)



Question 9 continued

DO NOT WRITE IN THIS AREA

DO NOT WRITE IN THIS AREA

DO NOT WRITE IN THIS AREA

Handwriting practice area with 25 horizontal dotted lines.



P 4 5 9 1 8 A 0 2 3 3 6

Question 9 continued

Area with horizontal dotted lines for writing.

DO NOT WRITE IN THIS AREA

DO NOT WRITE IN THIS AREA

DO NOT WRITE IN THIS AREA



Question 9 continued

DO NOT WRITE IN THIS AREA

DO NOT WRITE IN THIS AREA

DO NOT WRITE IN THIS AREA

Area with horizontal dotted lines for writing.

(Total for Question 9 is 12 marks)



P 4 5 9 1 8 A 0 2 5 3 6

10 (a) Show that the size of each interior angle of a regular pentagon is 108°

(2)

Diagram **NOT** accurately drawn

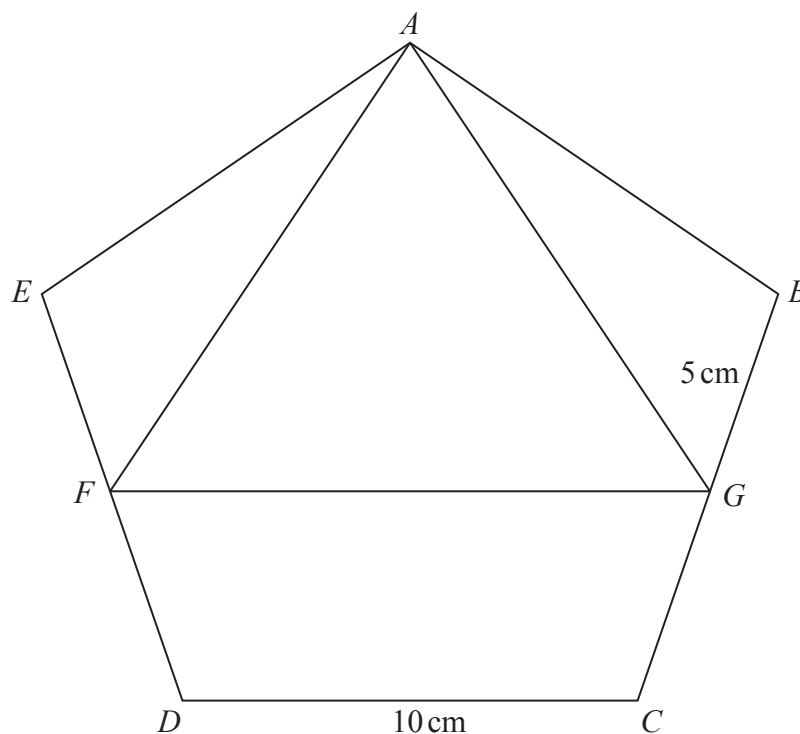

Figure 3

In Figure 3, $ABCDE$ is a regular pentagon with sides of length 10 cm. The midpoints of ED and BC are F and G respectively.

Calculate, giving your answers to 3 significant figures,

(b) the length, in cm, of AG ,

(3)

(c) the size, in degrees, of $\angle GAB$,

(3)

(d) the area, in cm^2 , of triangle GAF .

(3)

The area of the pentagon, to 4 significant figures, is 172.0 cm^2

The region R consists of the points inside the pentagon but outside the triangle GAF .

(e) Express the area of R as a percentage of the area of the pentagon. Give your answer to 3 significant figures.

(3)

$$\left(\begin{array}{l} \text{Sum of interior angles of polygon} = (2n - 4) \text{ right angles} \\ \text{Sine rule: } \frac{a}{\sin A} = \frac{b}{\sin B} = \frac{c}{\sin C} \\ \text{Cosine rule: } a^2 = b^2 + c^2 - 2bc \cos A \\ \text{Area of triangle} = \frac{1}{2} bc \sin A \end{array} \right)$$



Question 10 continued

DO NOT WRITE IN THIS AREA

DO NOT WRITE IN THIS AREA

DO NOT WRITE IN THIS AREA

Area with horizontal dotted lines for writing.



Question 10 continued

Handwriting practice area consisting of 20 horizontal dotted lines.

DO NOT WRITE IN THIS AREA

DO NOT WRITE IN THIS AREA

DO NOT WRITE IN THIS AREA



Question 10 continued

DO NOT WRITE IN THIS AREA

DO NOT WRITE IN THIS AREA

DO NOT WRITE IN THIS AREA

Area with horizontal dotted lines for writing.

(Total for Question 10 is 14 marks)



P 4 5 9 1 8 A 0 2 9 3 6

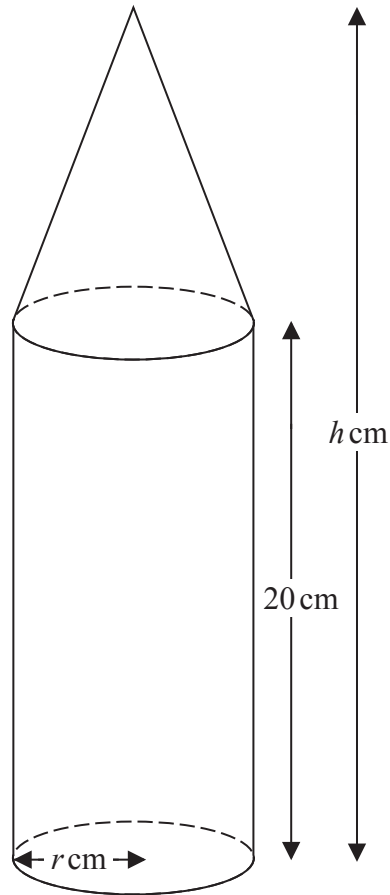

Diagram **NOT**
accurately drawn

Figure 4

Figure 4 shows a firework which is made of a right circular cone on top of a right circular cylinder. The radius of the base of the cone is r cm and the radius of the cylinder is also r cm. The centre of the base of the cone coincides with the centre of the upper circular face of the cylinder.

The height of the cylinder is 20 cm, the height of the cone is H cm and the total height of the firework is h cm.

(a) Write down an expression for H in terms of h .

(1)

The volume of the cone is V cm³

(b) Write down a formula for V in terms of r and h .

(1)

$$\left(\begin{array}{l} \text{Area of a circle} = \pi r^2 \\ \text{Volume of a right circular cone} = \frac{1}{3} \pi r^2 h \end{array} \right)$$



DO NOT WRITE IN THIS AREA

DO NOT WRITE IN THIS AREA

DO NOT WRITE IN THIS AREA

Question 11 continued

For this firework, $r + h = 32$

(c) Show that $V = \pi(4r^2 - \frac{1}{3}r^3)$

(2)

Area with horizontal dotted lines for writing the solution.

Question 11 continues on the next page



P 4 5 9 1 8 A 0 3 1 3 6

Question 11 continued

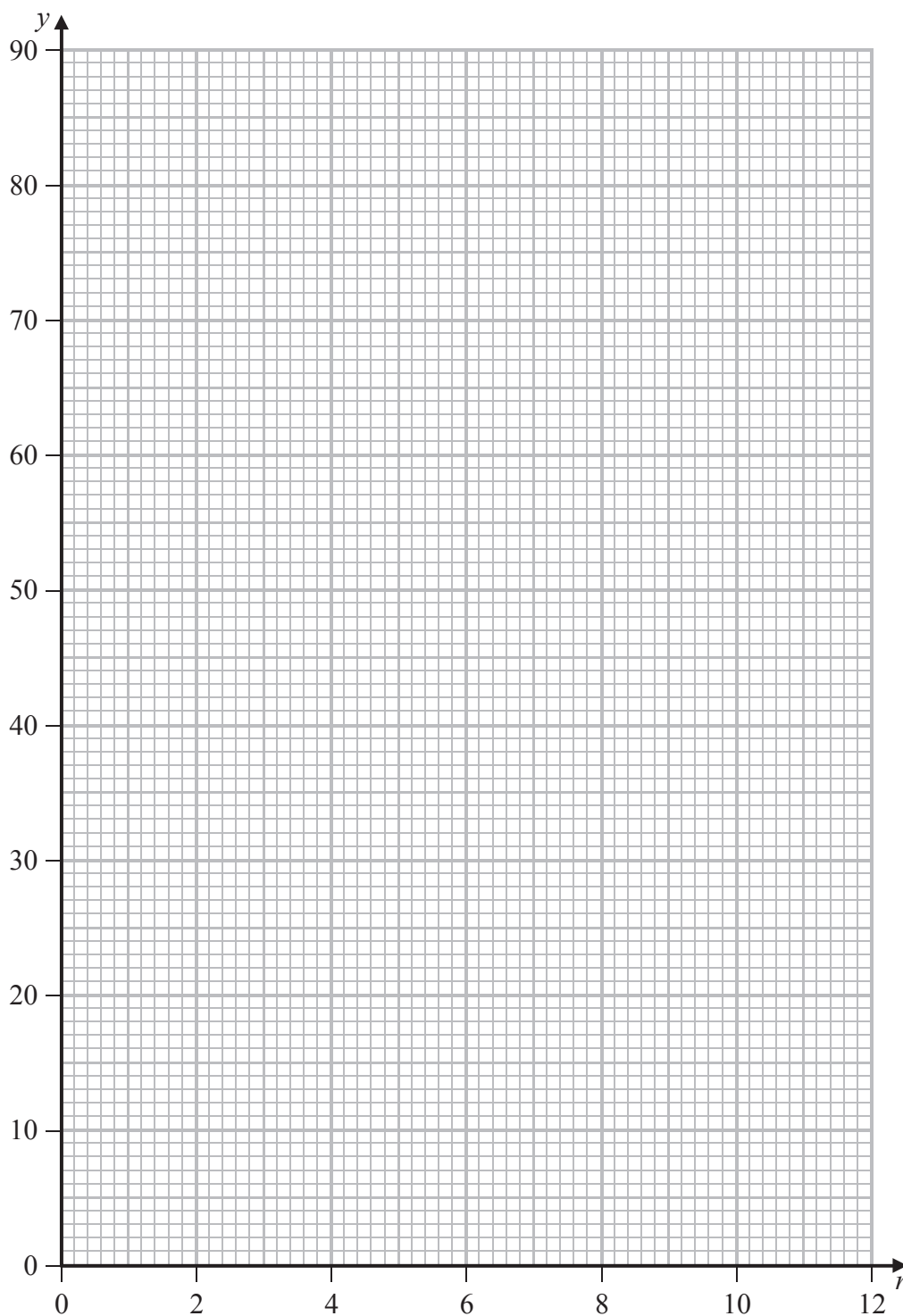

Turn over for a spare grid if you need to redraw your graph.

DO NOT WRITE IN THIS AREA



P 4 5 9 1 8 A 0 3 3 3 6

Question 11 continued

Handwriting practice area consisting of 25 horizontal dotted lines.

DO NOT WRITE IN THIS AREA

DO NOT WRITE IN THIS AREA

DO NOT WRITE IN THIS AREA



Question 11 continued

Only use this grid if you need to redraw your graph.

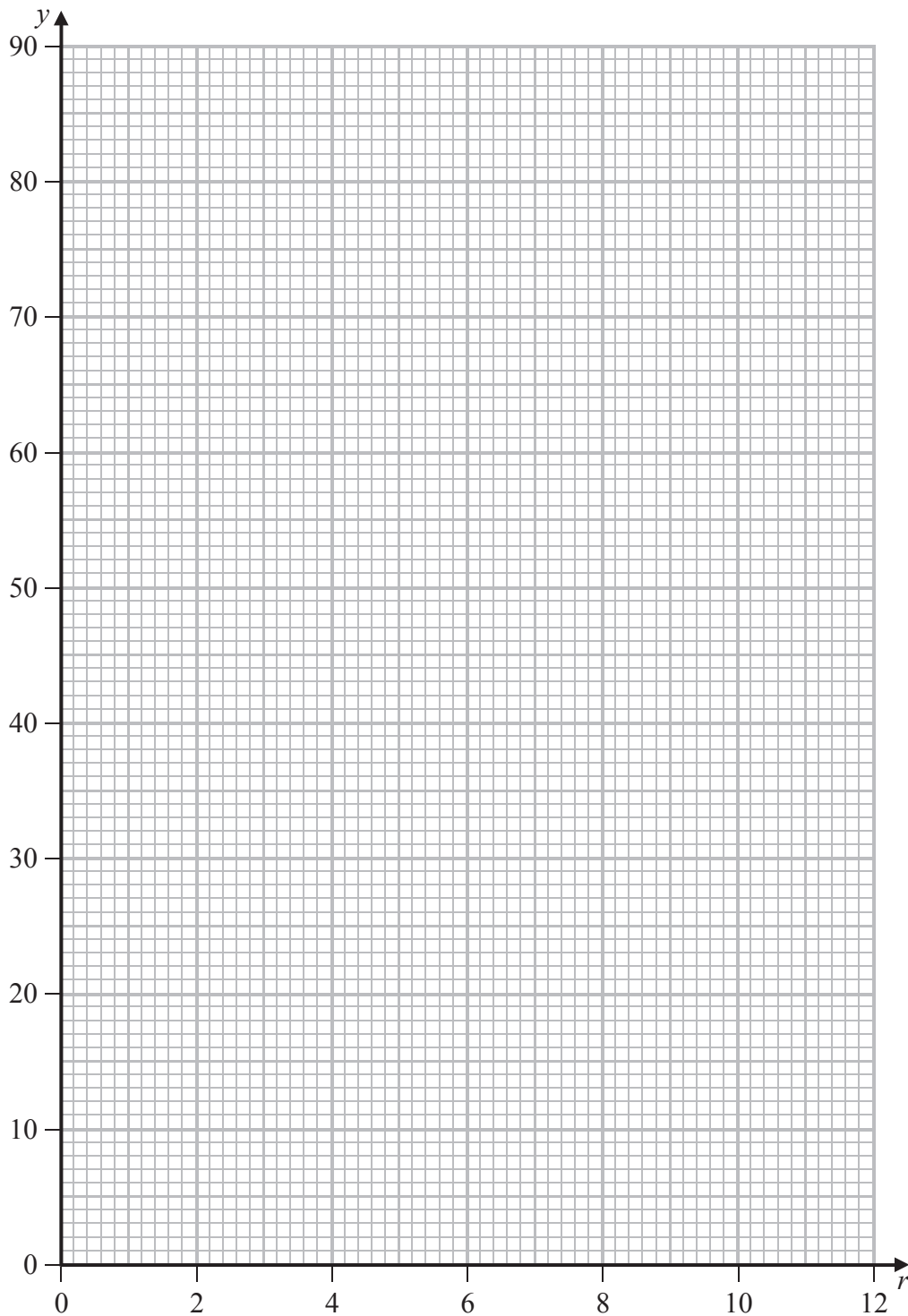

DO NOT WRITE IN THIS AREA

DO NOT WRITE IN THIS AREA

DO NOT WRITE IN THIS AREA



Question 11 continued

Area with horizontal dotted lines for writing.

(Total for Question 11 is 16 marks)

TOTAL FOR PAPER IS 100 MARKS

DO NOT WRITE IN THIS AREA

DO NOT WRITE IN THIS AREA

DO NOT WRITE IN THIS AREA

