

Write your name here

Surname

Other names

Edexcel Certificate

Centre Number

Candidate Number

**Edexcel
International GCSE**

--	--	--	--	--

--	--	--	--

Mathematics A

Paper 3H



Higher Tier

Friday 11 January 2013 – Morning

Time: 2 hours

Paper Reference

**4MA0/3H
KMA0/3H**

You must have:

Ruler graduated in centimetres and millimetres, protractor, compasses, pen, HB pencil, eraser, calculator. Tracing paper may be used.

Total Marks

Instructions

- Use **black** ink or ball-point pen.
- **Fill in the boxes** at the top of this page with your name, centre number and candidate number.
- Answer **all** questions.
- Without sufficient working, correct answers may be awarded no marks.
- Answer the questions in the spaces provided
– *there may be more space than you need.*
- **Calculators may be used.**
- You must **NOT** write anything on the formulae page.
Anything you write on the formulae page will gain **NO** credit.

Information

- The total mark for this paper is 100.
- The marks for **each** question are shown in brackets
– *use this as a guide as to how much time to spend on each question.*

Advice

- Read each question carefully before you start to answer it.
- Check your answers if you have time at the end.

Turn over ►

P41038A

©2013 Pearson Education Ltd.

6/6/5/6/6/



PEARSON

**International GCSE MATHEMATICS
FORMULAE SHEET – HIGHER TIER**

Pythagoras' Theorem

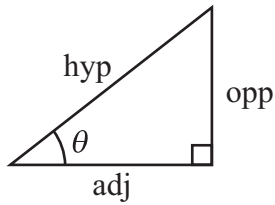
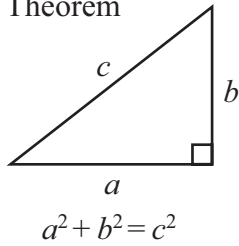

adj = hyp \times cos θ
opp = hyp \times sin θ
opp = adj \times tan θ

or $\sin \theta = \frac{\text{opp}}{\text{hyp}}$

$\cos \theta = \frac{\text{adj}}{\text{hyp}}$

$\tan \theta = \frac{\text{opp}}{\text{adj}}$

Volume of cone = $\frac{1}{3} \pi r^2 h$

Curved surface area of cone = $\pi r l$

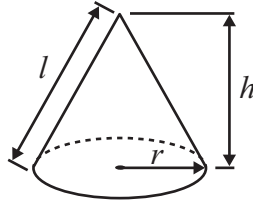

Volume of sphere = $\frac{4}{3} \pi r^3$

Surface area of sphere = $4 \pi r^2$

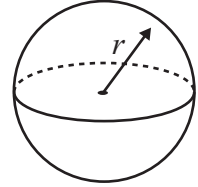

In any triangle ABC

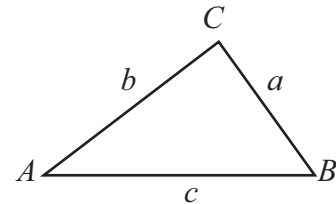

Sine rule: $\frac{a}{\sin A} = \frac{b}{\sin B} = \frac{c}{\sin C}$

Cosine rule: $a^2 = b^2 + c^2 - 2bc \cos A$

Area of triangle = $\frac{1}{2} ab \sin C$

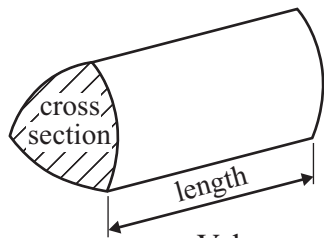

Volume of prism = area of cross section \times length

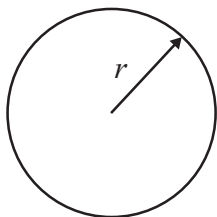

Circumference of circle = $2 \pi r$

Area of circle = πr^2

Area of a trapezium = $\frac{1}{2} (a + b) h$

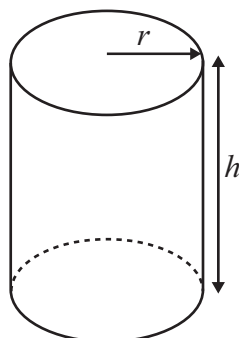
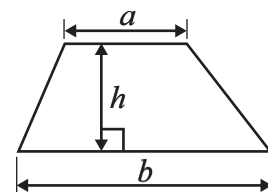

Volume of cylinder = $\pi r^2 h$

Curved surface area of cylinder = $2 \pi r h$

The Quadratic Equation
The solutions of $ax^2 + bx + c = 0$,
where $a \neq 0$, are given by

$$x = \frac{-b \pm \sqrt{b^2 - 4ac}}{2a}$$



Answer ALL TWENTY ONE questions.

Write your answers in the spaces provided.

You must write down all stages in your working.

1 Here is a biased 5-sided spinner.

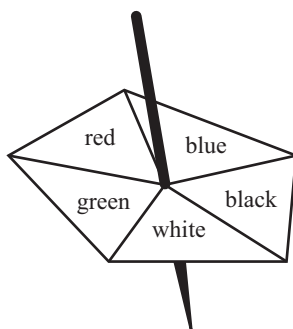

When the spinner is spun, it can land on red, blue, black, white or green.
The probability that it lands on red, blue, black or white is given in the table.

Colour	red	blue	black	white	green
Probability	0.18	0.20	0.23	0.22	

George spins the spinner once.

(a) Work out the probability that the spinner lands on green.

.....
(2)

Heena spins the spinner 40 times.

(b) Work out an estimate for the number of times the spinner lands on blue.

.....
(2)

(Total for Question 1 is 4 marks)



- 2 Rectangle **A** has a width of x metres and a height of $(x + 2)$ metres.
Rectangle **B** has a width of $2x$ metres and a height of $4x$ metres.

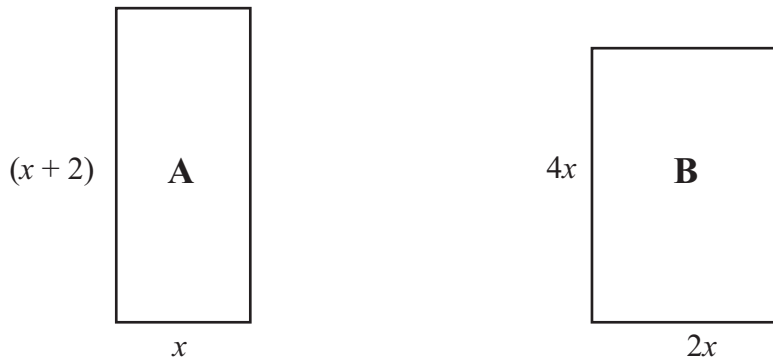

Diagram **NOT**
accurately drawn

The perimeter of rectangle **A** is equal to the perimeter of rectangle **B**.

- (i) Use this information to write down an equation in x .

.....

- (ii) Find the value of x .

$x =$

(Total for Question 2 is 4 marks)



3 Joseph travels to work each day by train.
The weekly cost of his train journey is £45
Joseph's weekly pay is £625

(a) Work out 45 as a percentage of 625

..... %
(2)

(b) The weekly cost of his train journey increases by 8%.

Increase £45 by 8%.

£
(3)

(c) Joseph's weekly pay increases to £640

Calculate the percentage increase from 625 to 640

..... %
(3)

(d) Joseph decides to cycle to work.

He cycles 18 km to work.

His journey to work takes 1 hour 20 minutes.

Calculate his average speed in kilometres per hour.

..... km/h
(3)

(Total for Question 3 is 11 marks)



4

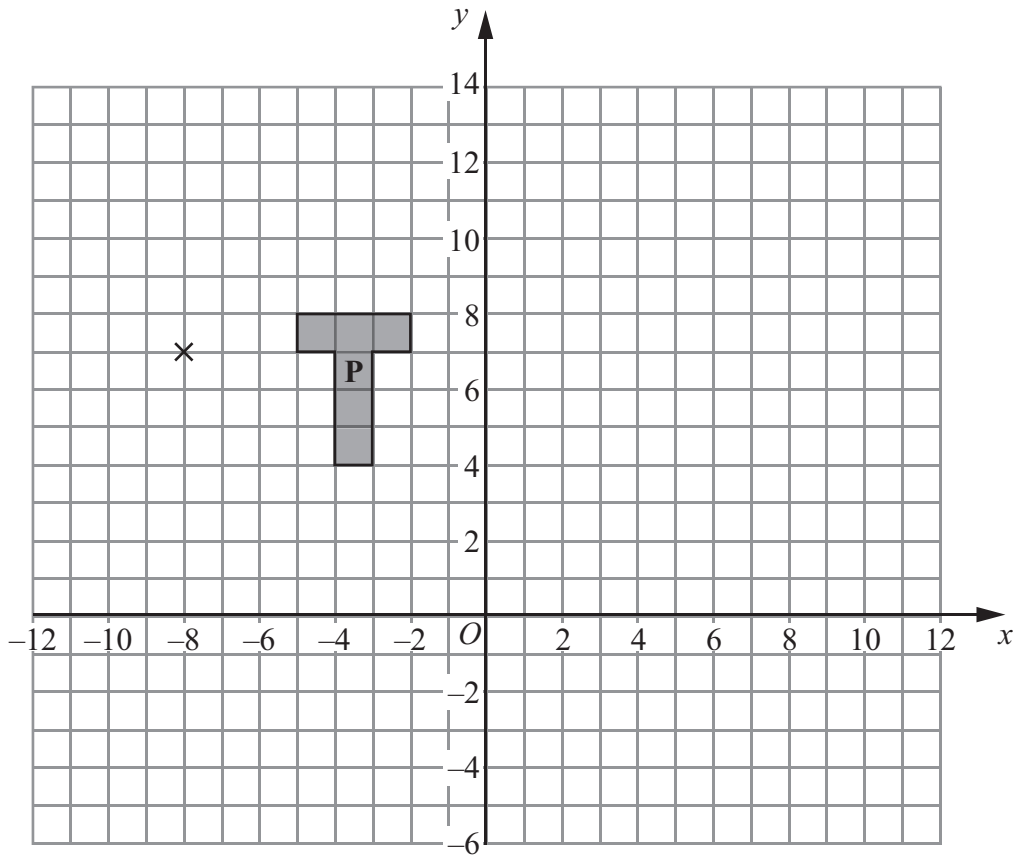

- (a) On the grid, enlarge shape **P** with scale factor 3 and centre $(-8, 7)$.
Label the new shape **Q**. (3)
- (b) On the grid, rotate shape **P** through 90° clockwise about the point $(-8, 7)$.
Label the new shape **R**. (2)

(Total for Question 4 is 5 marks)

5 Solve the simultaneous equations

$$\begin{aligned} y - 2x &= 6 \\ y + 2x &= 0 \end{aligned}$$

Show clear algebraic working.

$x =$

$y =$

(Total for Question 5 is 3 marks)



6 A school has 60 teachers.

The table shows information about the distances, in km, the teachers travel to school each day.

Distance (d km)	Frequency
$0 < d \leq 5$	12
$5 < d \leq 10$	6
$10 < d \leq 15$	4
$15 < d \leq 20$	6
$20 < d \leq 25$	14
$25 < d \leq 30$	18

(a) Write down the modal class.

.....
(1)

(b) Work out an estimate for the total distance travelled to school by the 60 teachers each day.

..... km
(3)

(Total for Question 6 is 4 marks)

7 (i) Solve the inequalities $-2 < x + 2 \leq 5$

.....

(ii) On the number line, represent the solution to part (i).

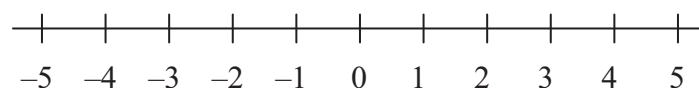

(Total for Question 7 is 4 marks)



8

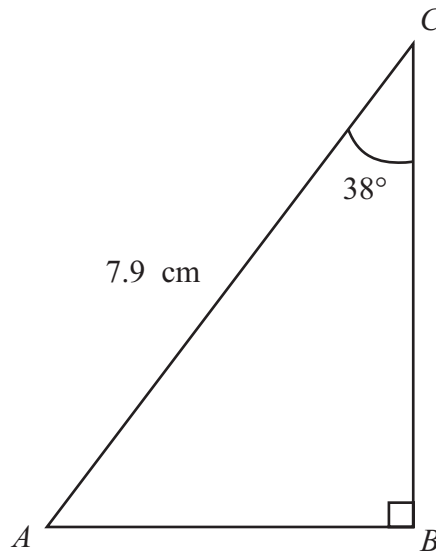

Diagram NOT accurately drawn

ABC is a triangle.
 $AC = 7.9$ cm
Angle $B = 90^\circ$
Angle $C = 38^\circ$

- (a) Calculate the length of BC .
Give your answer correct to 3 significant figures.

..... cm
(3)

- (b) The size of angle C is 38° , correct to 2 significant figures.

- (i) Write down the lower bound of the size of angle C .

.....
o

- (ii) Write down the upper bound of the size of angle C .

.....
o
(2)

(Total for Question 8 is 5 marks)



9 The table shows the diameters, in kilometres, of five planets.

Planet	Diameter (km)
Venus	1.2×10^4
Jupiter	1.4×10^5
Neptune	5.0×10^4
Mars	6.8×10^3
Saturn	1.2×10^5

(a) Which of these planets has the smallest diameter?

.....
(1)

(b) Calculate the difference, in kilometres, between the diameter of Saturn and the diameter of Neptune.
Give your answer in standard form.

..... km
(2)

The diameter of the Moon is 3.5×10^3 km.
The diameter of the Sun is 1.4×10^6 km.

(c) Calculate the ratio of the diameter of the Moon to the diameter of the Sun.
Give your answer in the form $1 : n$

.....
(2)

(Total for Question 9 is 5 marks)



10 The points $(0, -1)$ and $(4, 5)$ lie on the straight line **L**.

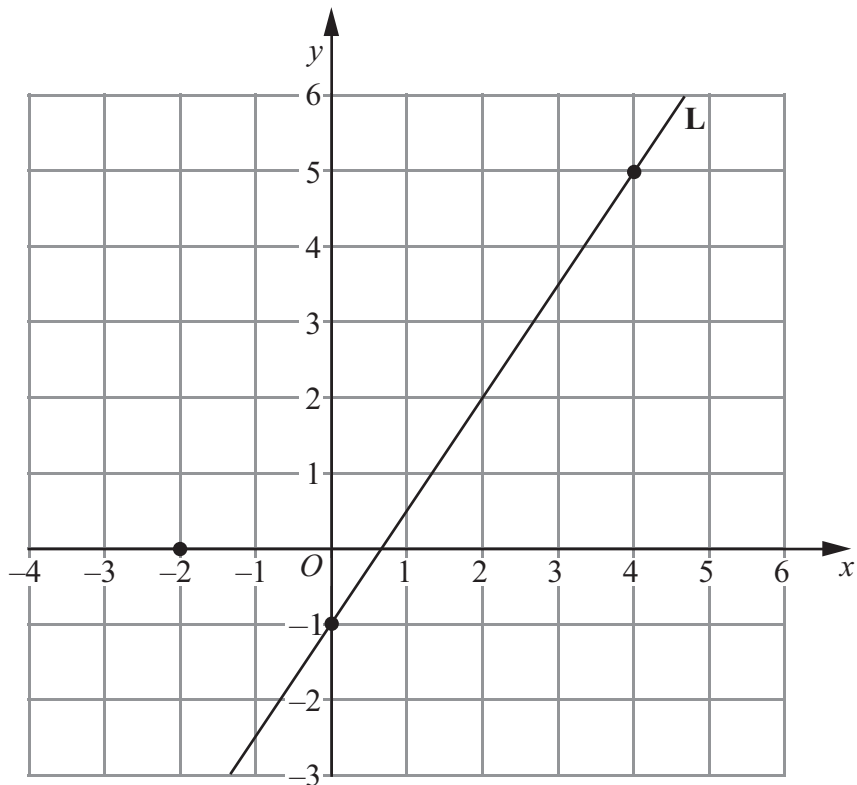

(a) Work out the gradient of **L**.

.....
(2)

(b) Write down an equation of **L**.

.....
(1)

(c) Find an equation of the line which is parallel to **L** and passes through the point $(-2, 0)$

.....
(2)

(Total for Question 10 is 5 marks)



- 11 A washing line is attached at points A and B on two vertical posts standing on horizontal ground.
 Point A is 2.1 metres above the ground on one post.
 Point B is 1.7 metres above the ground on the other post.
 The horizontal distance between the two posts is 6 metres.

Diagram **NOT** accurately drawn

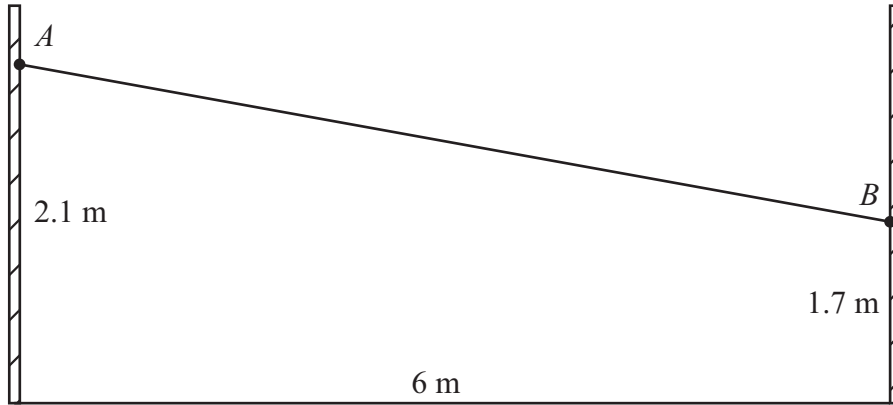

Calculate the distance AB .
 Give your answer correct to 3 significant figures.

..... m

(Total for Question 11 is 4 marks)

- 12 Make h the subject of the formula $A = 2\pi r(r + h)$

$h =$

(Total for Question 12 is 2 marks)



13 The incomplete table and histogram show information about the lengths of time, t minutes, students spent waiting for their school bus one morning.

Time (t minutes)	Number of students
$0 < t \leq 2$	20
$2 < t \leq 10$	120
$10 < t \leq 15$	60
$15 < t \leq 20$	
$20 < t \leq 30$	30

(i) Use the histogram to complete the table.

(ii) Use the table to complete the histogram.

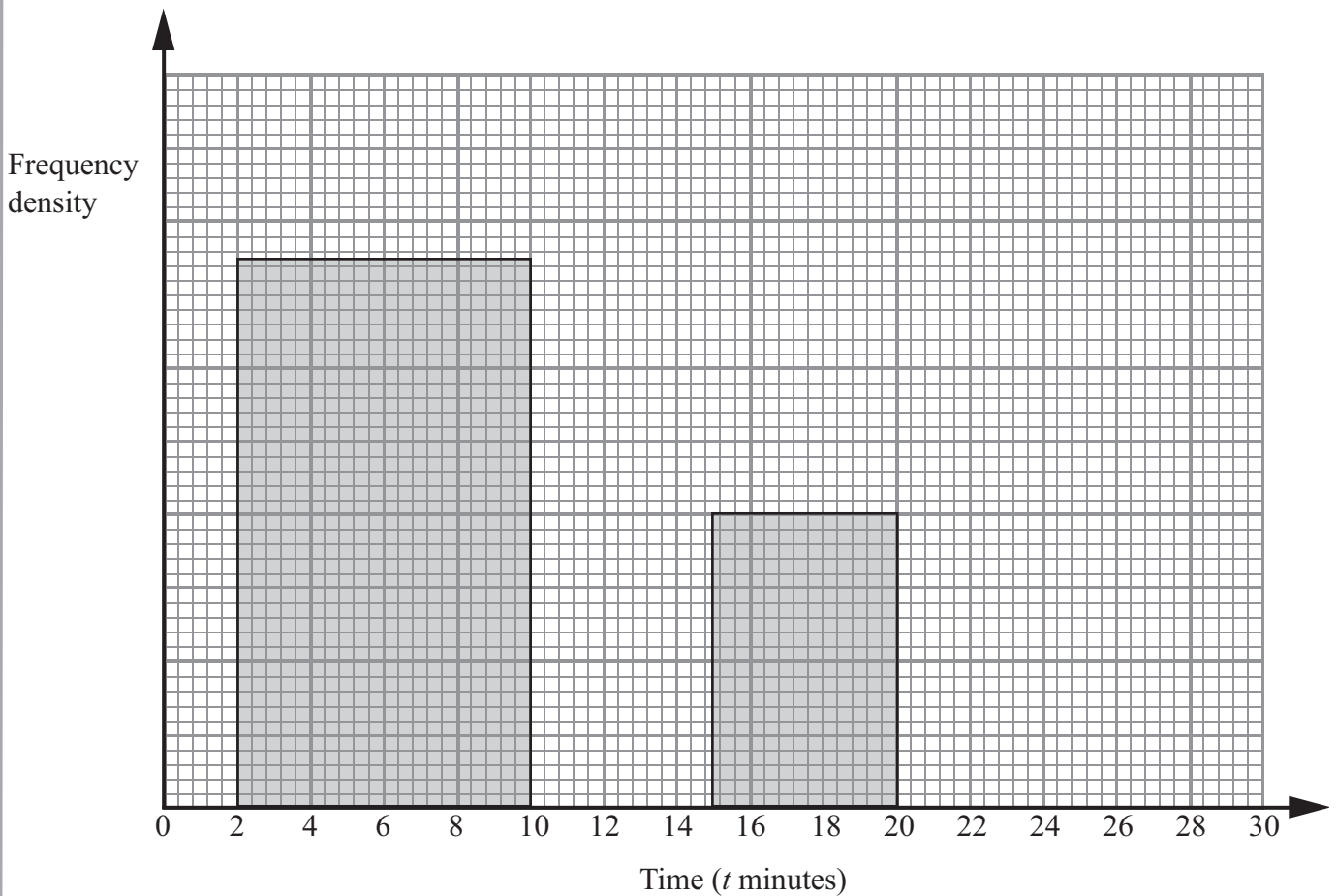

(Total for Question 13 is 4 marks)



15 The Venn diagram shows a universal set \mathcal{E} and three sets A , B and C .

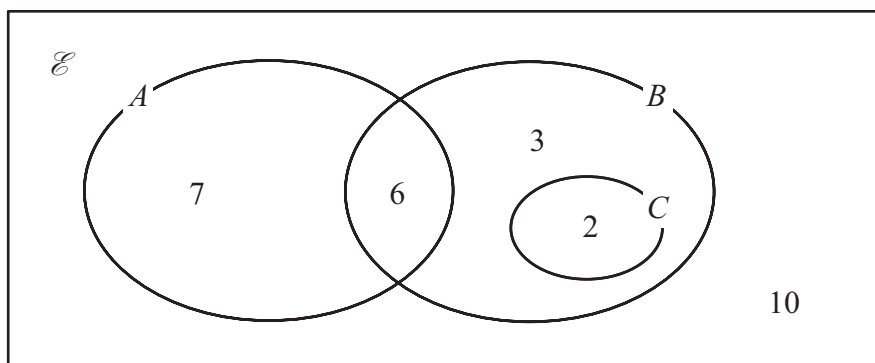

7, 6, 3, 2 and 10 represent the **numbers** of elements.

Find

(i) $n(A \cup B)$

.....

(ii) $n(A')$

.....

(iii) $n(B \cap C')$

.....

(iv) $n(A' \cup B')$

.....

(Total for Question 15 is 4 marks)

Do NOT write in this space.



16

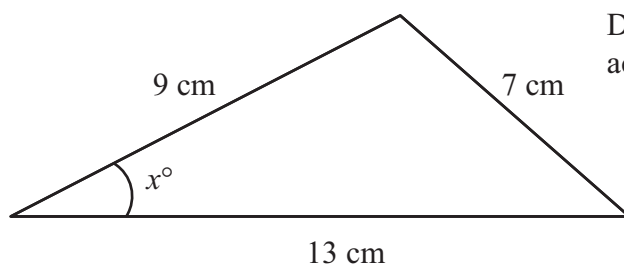

Diagram NOT
accurately drawn

Calculate the value of x .
Give your answer correct to 1 decimal place.

$x = \dots\dots\dots$

(Total for Question 16 is 3 marks)

17 Simplify fully $\frac{4x^2 - 25}{6x^2 + 13x - 5}$

$\dots\dots\dots$

(Total for Question 17 is 3 marks)



18 (a) Differentiate with respect to x

(i) $8x^2$

(ii) $\frac{2}{x}$

.....

.....

(3)

(b) The curve with equation $y = 8x^2 + \frac{2}{x}$ has one turning point.

Find the coordinates of this turning point.
Show your working clearly.

(.....,))

(4)

(Total for Question 18 is 7 marks)



19 The diagram shows a rectangular playground of width x metres and length $3x$ metres.

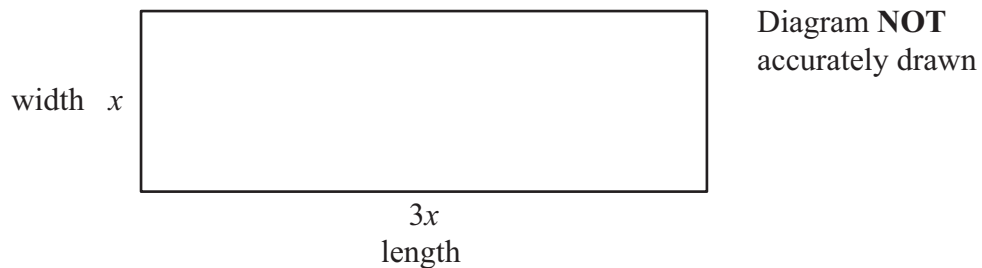

The playground is extended, by adding 10 metres to its width and 20 metres to its length, to form a larger rectangular playground.

The area of the larger rectangular playground is double the area of the original playground.

(a) Show that $3x^2 - 50x - 200 = 0$

(3)

(b) Calculate the area of the original playground.

..... m²

(5)

(Total for Question 19 is 8 marks)



20 The diagram shows a parallelogram, $PQRS$.

M is the midpoint of PS .

$$\vec{PM} = \mathbf{a} \quad \vec{PQ} = \mathbf{b}$$

Diagram **NOT** accurately drawn

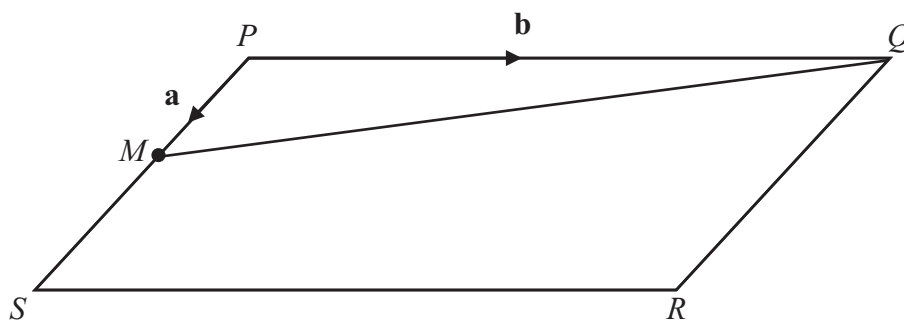

(a) Find, in terms of \mathbf{a} and/or \mathbf{b} ,

(i) \vec{PS}

(ii) \vec{PR}

(iii) \vec{MQ}

.....

.....

.....

(3)

N is the point on MQ such that $MN = \frac{1}{3}MQ$

(b) Use a vector method to prove that PNR is a straight line.

(2)

(Total for Question 20 is 5 marks)



- 21 The diagram shows a pyramid with a horizontal rectangular base $PQRS$.
 $PQ = 16$ cm.
 $QR = 10$ cm.
 M is the midpoint of the line PR .
The vertex, T , is vertically above M .
 $MT = 15$ cm.

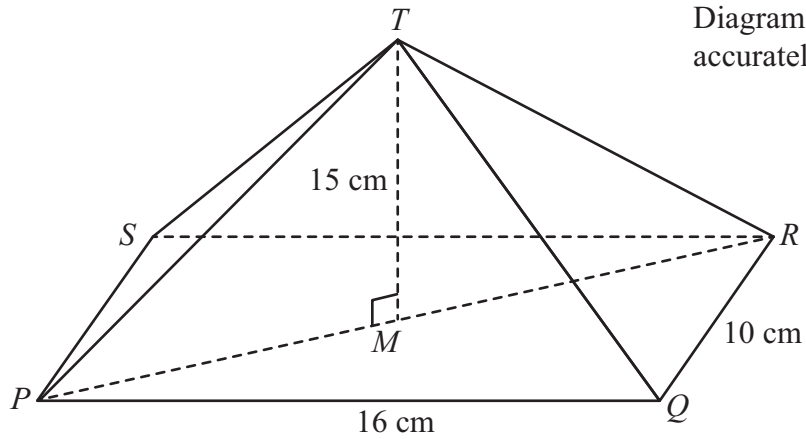

Diagram NOT
accurately drawn

Calculate the size of the angle between TP and the base $PQRS$.
Give your answer correct to 1 decimal place.

.....
(Total for Question 21 is 4 marks)

TOTAL FOR PAPER IS 100 MARKS



BLANK PAGE

Do NOT write on this page.

